

PLANTA DE DRENAGEM
ESCALA 1:500

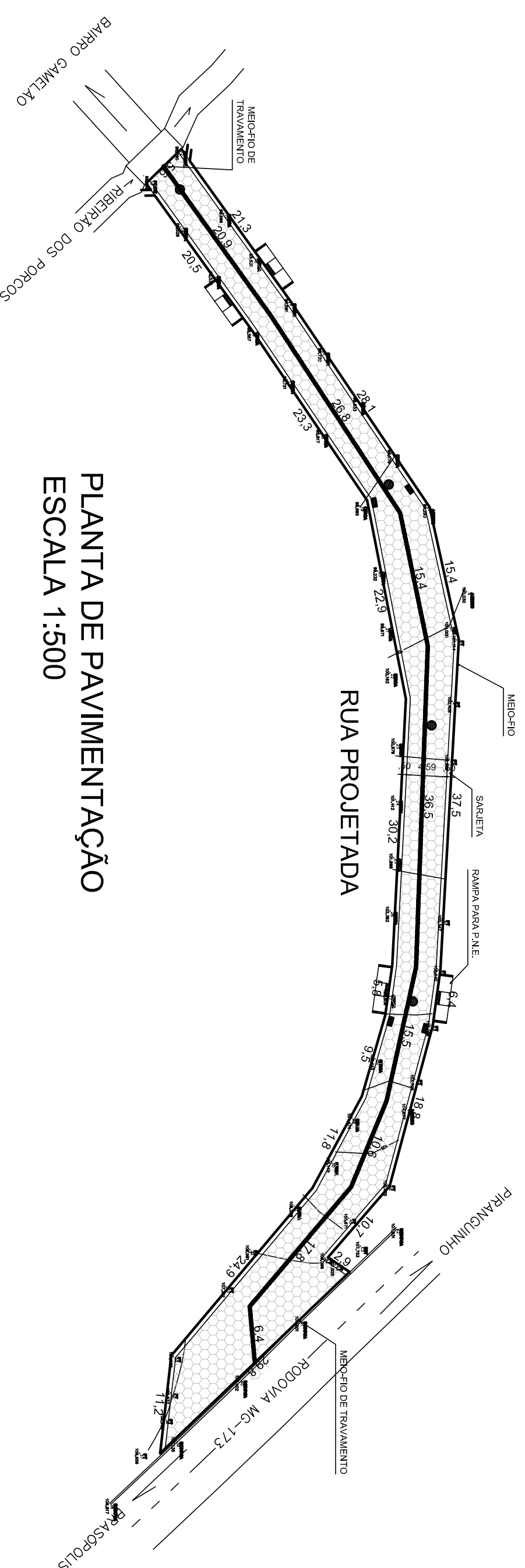

PLANTA DE PAVIMENTAÇÃO
ESCALA 1:500

Estaca	Distância	Elemento	Colo do Terreno	Distância	Estaca
00,000	0,00		98,546	0,00	0
00,000	5,00		98,584	5,00	1
00,000	10,00		98,614	10,00	2
00,000	15,00		98,589	15,00	3
00,000	20,00		98,595	20,00	4
00,000	25,00		98,671	25,00	5
00,000	30,00		98,757	30,00	6
00,000	35,00		98,827	35,00	7
00,000	40,00		98,928	40,00	8
00,000	45,00		99,072	45,00	9
00,000	50,00		99,289	50,00	10
00,000	55,00		99,528	55,00	11
00,000	60,00		99,781	60,00	12
00,000	65,00		100,168	65,00	13
00,000	70,00		100,643	70,00	14
00,000	75,00		101,035	75,00	15
00,000	80,00		101,334	80,00	16
00,000	85,00		101,705	85,00	17
00,000	90,00		102,077	90,00	18
00,000	95,00		102,424	95,00	19
00,000	100,00		102,886	100,00	20
00,000	105,00		103,299	105,00	21
00,000	110,00		103,443	110,00	22
00,000	115,00		103,788	115,00	23
00,000	120,00		104,294	120,00	24
00,000	125,00		104,064	125,00	25
00,000	130,00		106,064	130,00	26
00,000	135,00		106,882	135,00	27
00,000	140,00		107,309	140,00	28
00,000	145,00		107,878	145,00	29
00,000	150,00		107,258	150,00	30
00,000	155,00		107,137	155,00	31
00,000	160,00		107,050	160,00	32

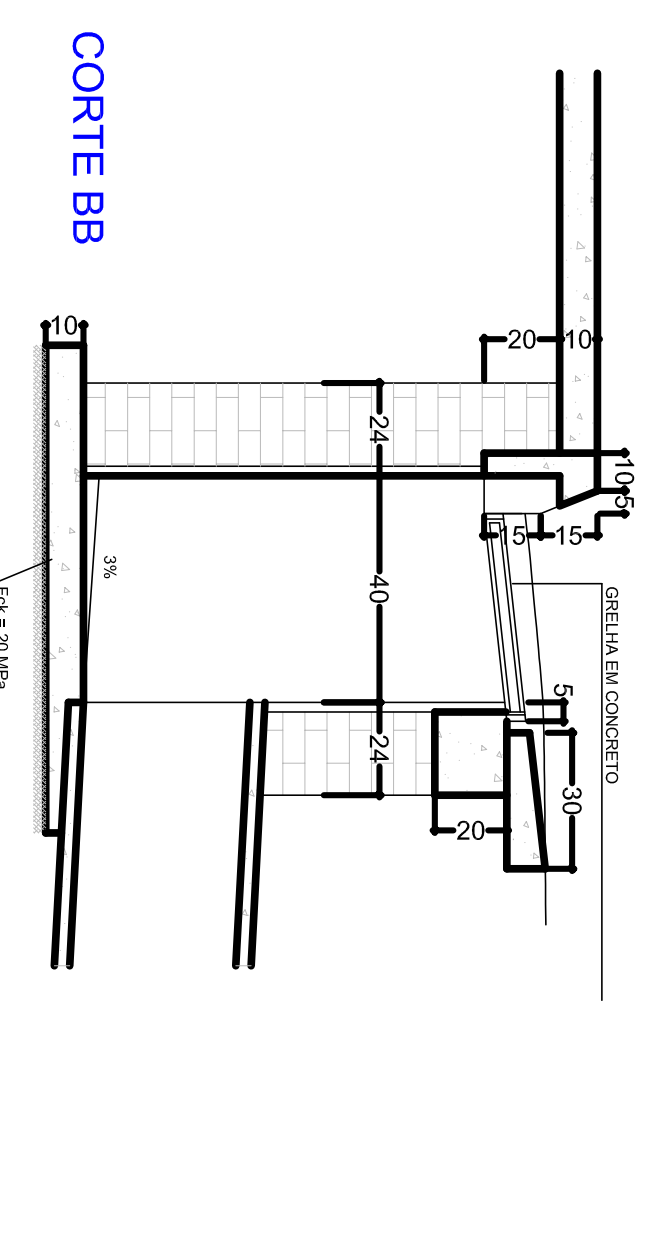
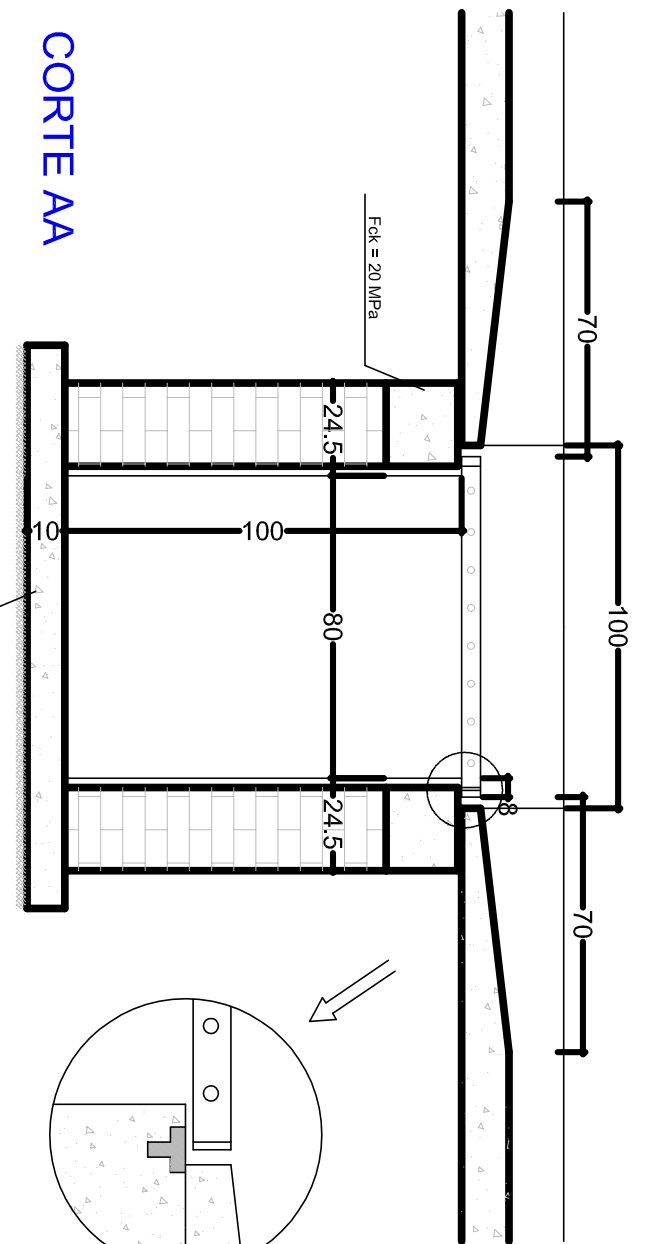
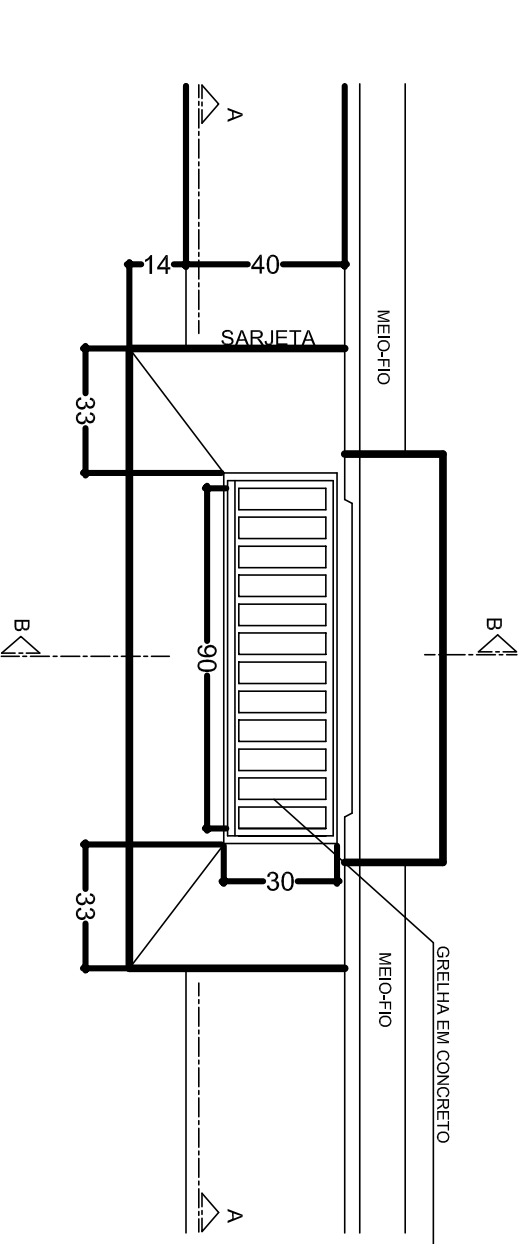
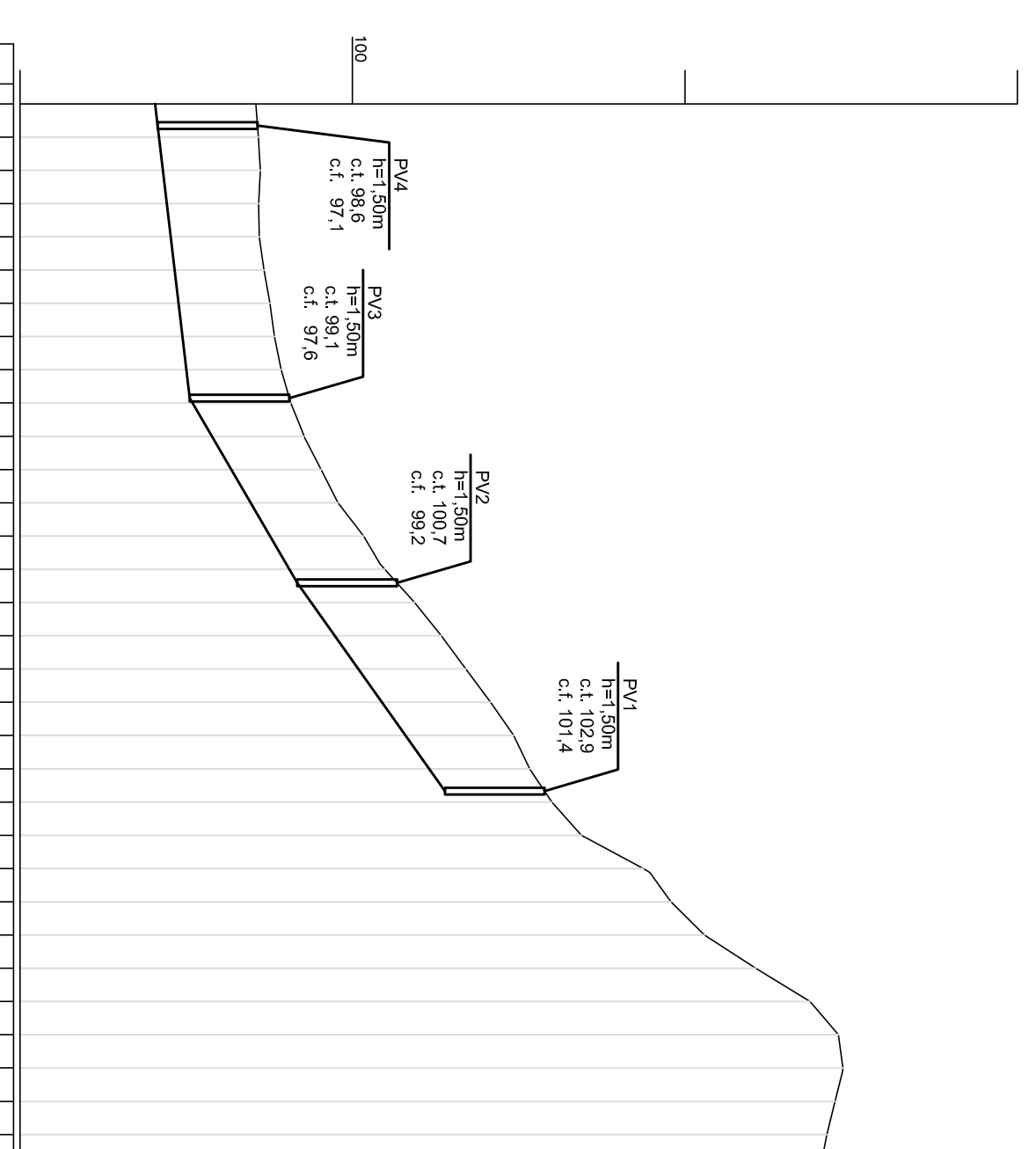

RAMPA DE ACESSO
PARA PORTADORES DE DEFICIÊNCIA

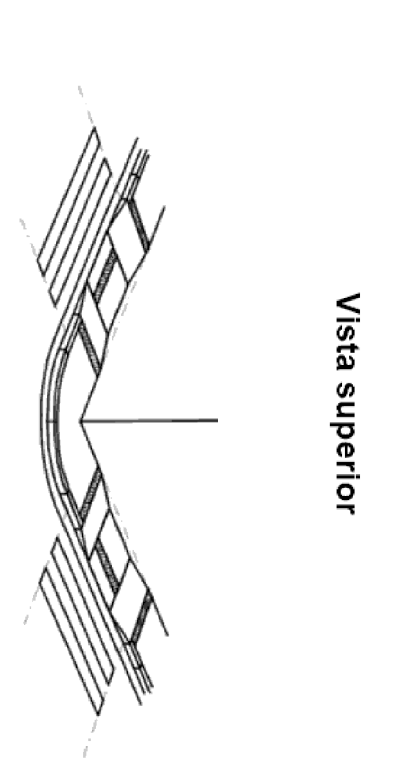
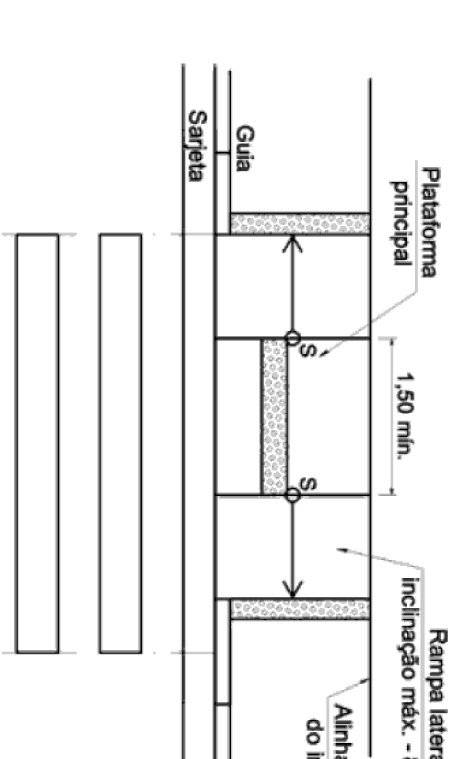

NOTA: NOS LOCAIS INDICADOS COM RAMPA O MEIO-FIO DEVE SER EXECUTADO COM REBAIXADO, PARA EXECUÇÃO DAS MESMAS NA FUTURA CONSTRUÇÃO DOS PASSEIOS

PROJETO DE INFRAESTRUTURA	PROPRIETÁRIO	PREFEITURA MUNICIPAL DE PINANGUINHO
ART. CONTRATO	LOCAL	RUA PROJETADA, BAIRRO LAJE, PINANGUINHO - MG
OBRA: PAVIMENTAÇÃO EM BLOCOS DE CONCRETO SEXTAVADOS E DRENAGEM PLUVIAL	DATA	FEBREIRO DE 2019
CONTEÚDO: PLANTAS E PERFIL	REVISÃO	ZERO
RESPONSÁVEL TÉCNICO: ENGR. CIVIL SERGIANO RODRIGUES FLORENCIO (CREA 51924/MS)	FOLHA	1/1
	CODIGO	

